

Streamline Frameless

Installation Instructions

Stand optional

This installation instruction is based on 135", and the Installation of other sizes can also refer to this instruction step for installation

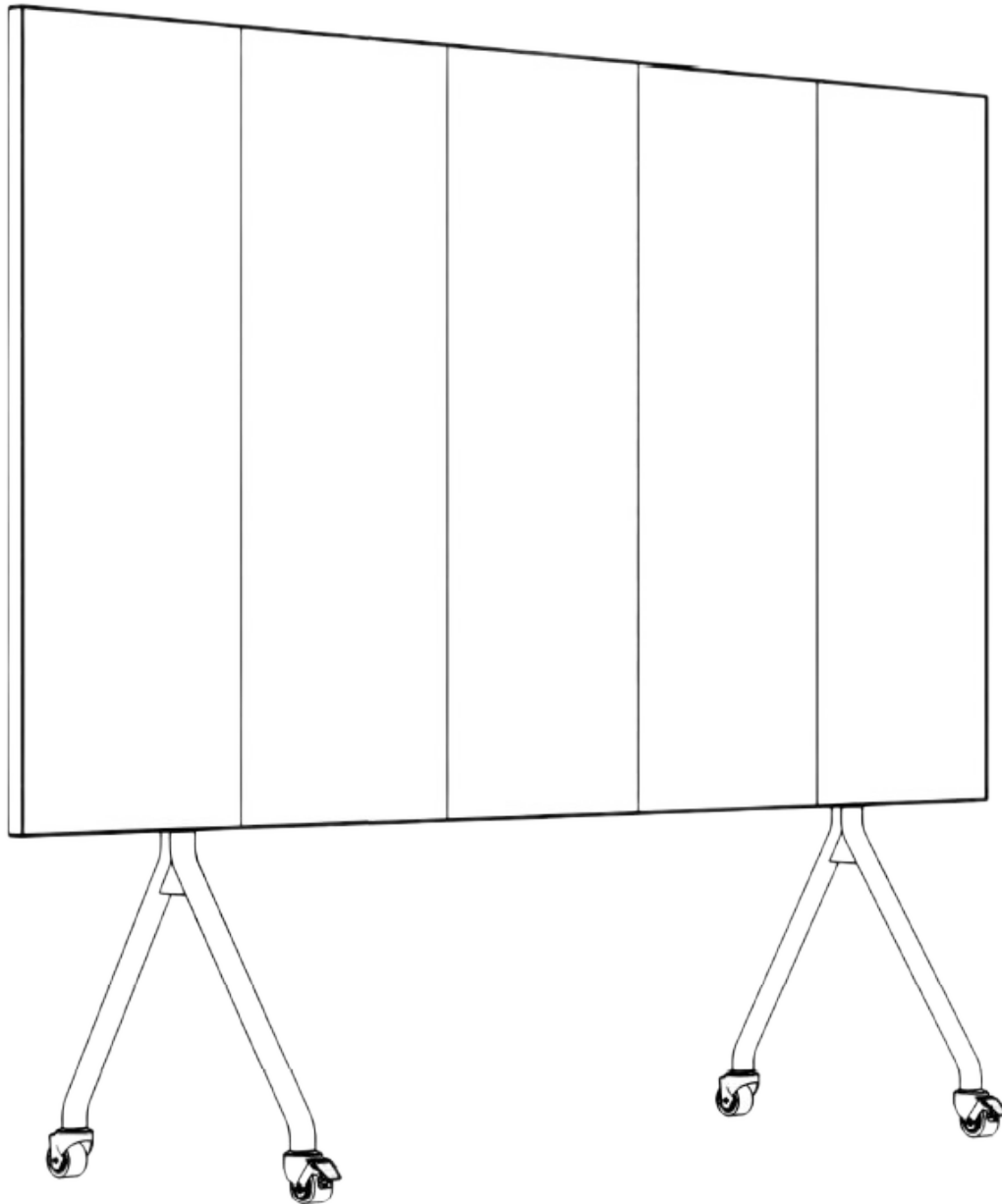

108"

135"

162"

Table of Content

Streamline Frameless – AIO

Wooden box packaging and internal placement	2
Packaging Contents	3
Product Overview	5
Control box and interface introduction	6
Remote control operation introduction	7
Connecting Equipment	8
Introduction About LED displays	9
Accessories List	10
Movable Base Installation	11
Wall mounted installation	13
Network/Power Connections	14
Screen Installation	15
Front Connecting Block	17
LED Module Installation	20
Mounting the Module Structure	21
Powering On the LED Screen	23
Maintenance & Service	24

Wooden box packaging and internal placement

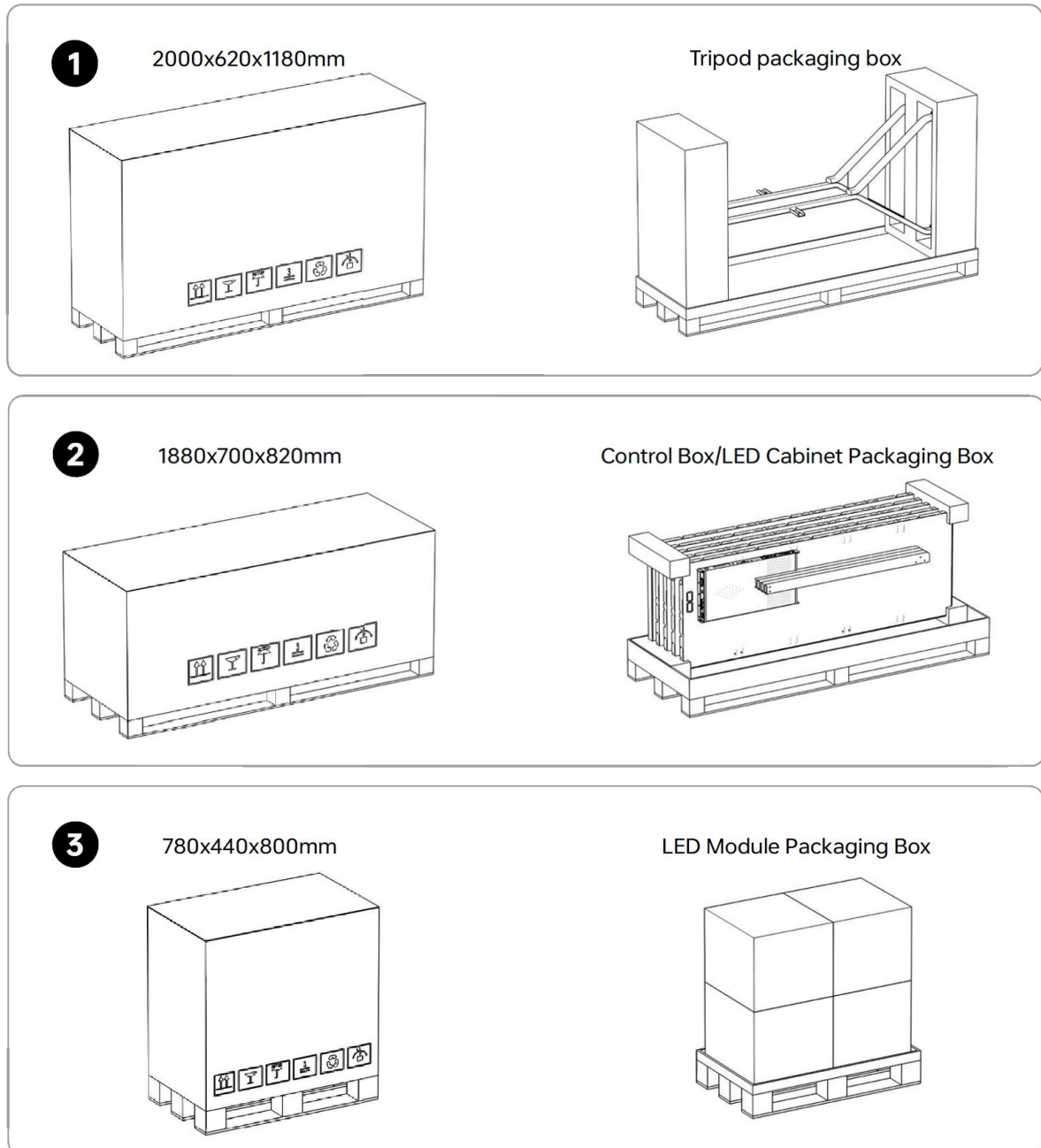

The stand/LED Cabinet/display panel is shipped in three packages.





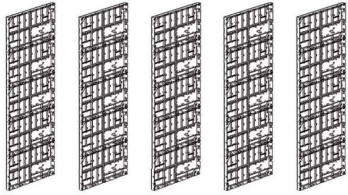

Packaging Contents

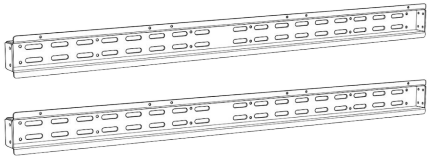
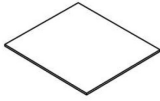
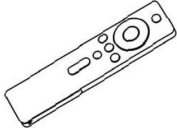
- 1) Use Pliers to open the wooden case.
- 2) Please wear protective equipment at all times, such as gloves and protective shoes.

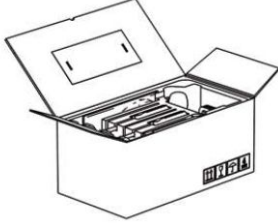
Before Installation: Carefully check if all accessories are included in the box. If any items are missing or damaged, please contact your dealer immediately.

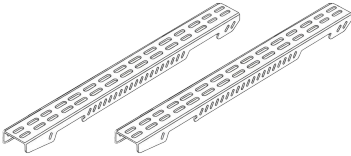
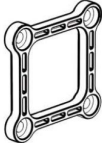
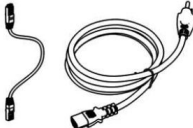
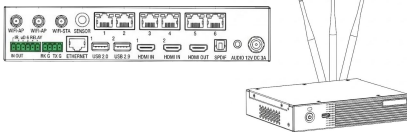
<p>Led Cabinet</p>		<p>5 pcs</p>	<p>5 Cabinets per row, total 5 rows</p>
<p>Movable Base (Optional)</p>		<p>1 set</p>	<p>Includes 2 legs, 2 crossbeams</p>
<p>Wall Mount</p>		<p>1 set</p>	<p>One bracket each on the top and bottom</p>
<p>Led Module</p>		<p>200 pcs</p>	<p>Includes spares, actual quantity may vary</p>
<p>Bluetooth Remote</p>		<p>1 pcs</p>	<p>/</p>

<p>USB Drive</p>		<p>1 pcs</p>	<p>Contains configuration files</p>
<p>Standard Toolkit</p>		<p>1 set</p>	<p>Includes T-shaped wrenches #3,#4,#5,#6, adjustment tools, flat screwdrivers, Phillips screwdriver, manual maintenance tool</p>
<p>Screw</p>		<p>1 set</p>	<p>M6 x 20 hex screws, M6 x 12 countersunk screws, M4 x 12 screws, m6 x 30 screws, m5 x 25 screws.</p>
<p>Mounting Bracket</p>		<p>4x4 - 6 5x5 - 6 6x6 -</p>	<p>M6 x 20 Hex screws included</p>
<p>Front Connector</p>		<p>57 pcs</p>	<p>M4 x 12 Screws included</p>
<p>Network & Power Cables</p>		<p>/</p>	<p>/</p>
<p>Control box</p>		<p>1 pcs</p>	<p>Multi-port & multifunction control box</p>
<p>Gloves</p>		<p>1 pair</p>	<p>Anti-static dust-free gloves</p>

Notes: 1) This product is packaged in a wooden or flight case. 2) Due to the size and weight, multiple people or tools are recommended for handling. 3) You can identify the contents via the product labels on the package.

Product Overview

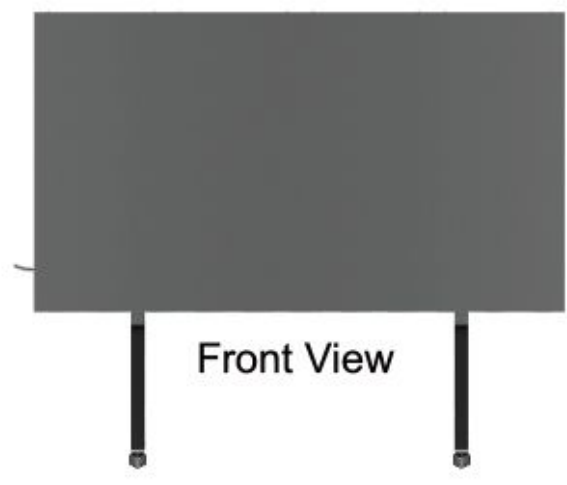
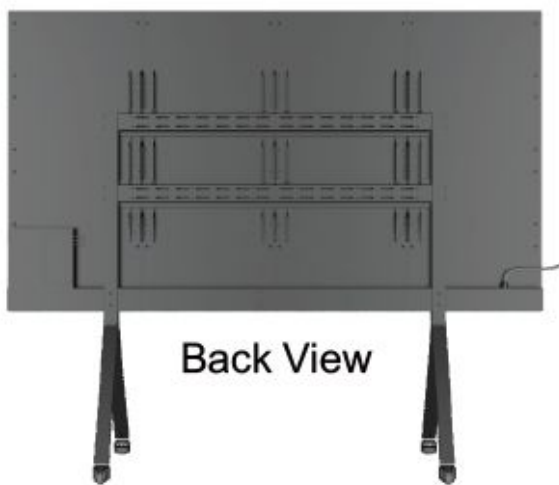
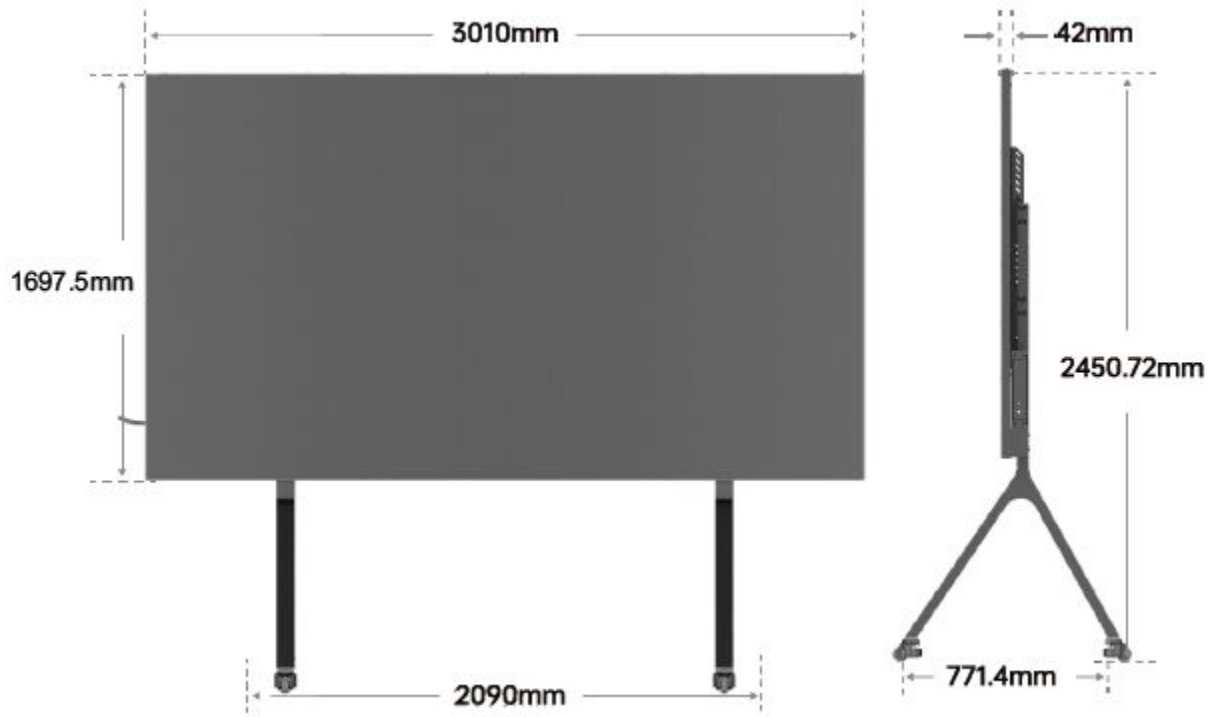

Control box and interface introduction

Support Bluetooth/WiFi connection.

Install Wifi antennas prior to installing power and signal rail.

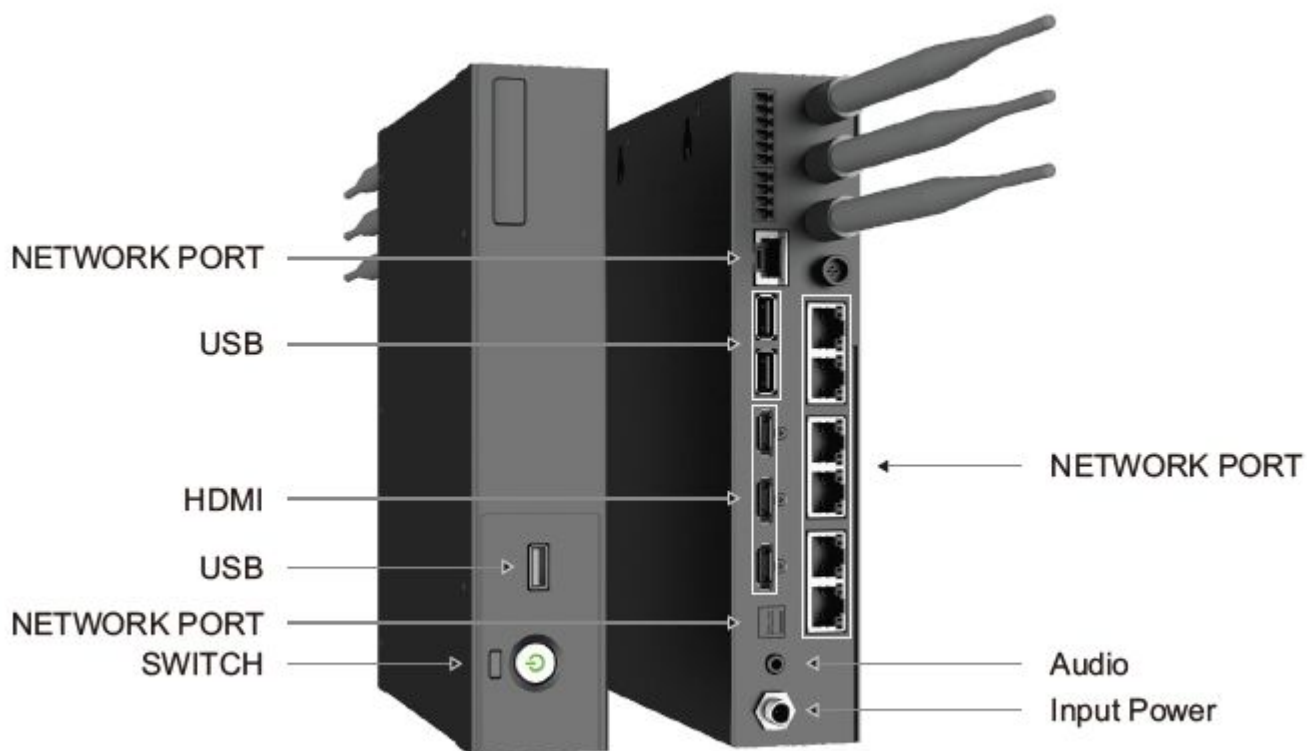

Remote control operation introduction

Support voice recognition function.

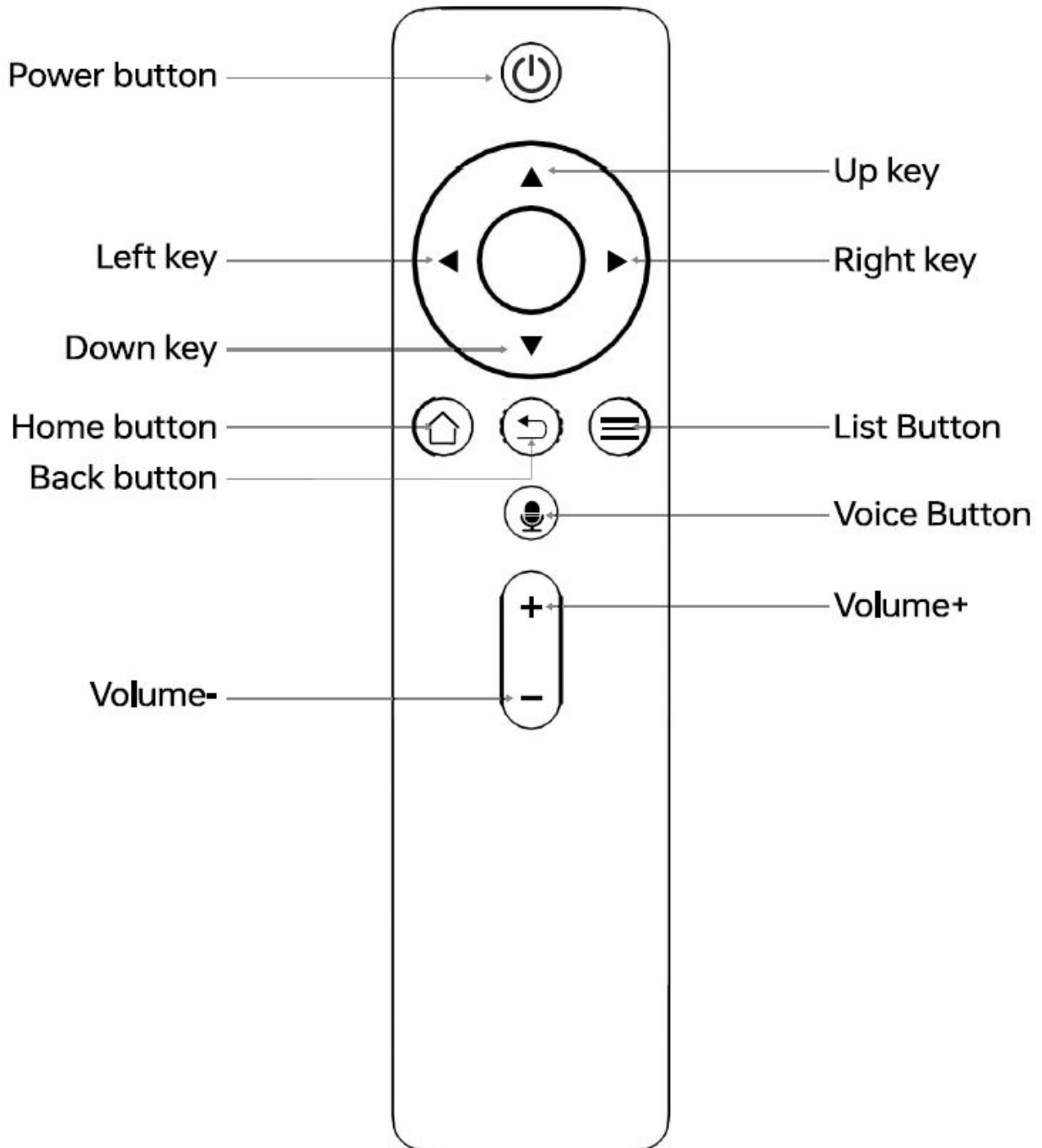

Connecting Equipment

The number of ports and the type of device will depend on the product received. The descriptions here are for illustration purposes only

Connect to the HDMI input

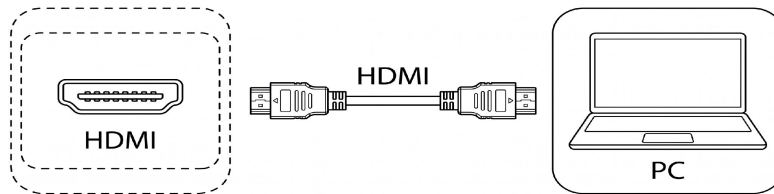

Figure 7

How to Connect

1. Use an HDMI cable to connect to your computer or other device that has an HDMI output.
2. Press the channel switch key (on the machine or remote control) to switch to the HDMI display channel.

Connect to the USB/USB-C ports

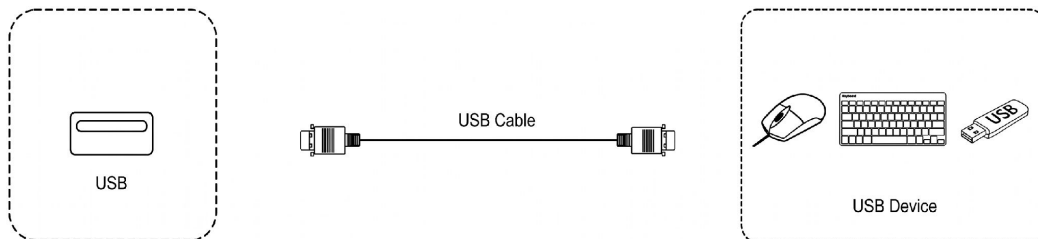

Figure 8

How to Connect

Connect a USB drive, mouse, or keyboard to the USB/USB-C interface.

- A mouse and keyboard can be used immediately after being connected to the USB/USB-C interface.
- To view the contents of a USB drive, open Explorer on the system home screen to read the files.
- USB-C supports DP-Alt Mode.

Introduction About LED displays













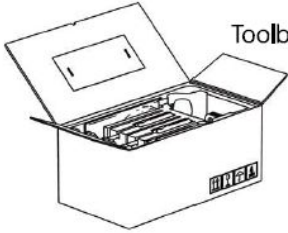

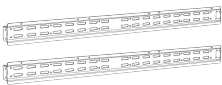
(optional) This LED display is installed on a movable base

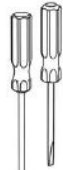

Pre-Installation Instruction

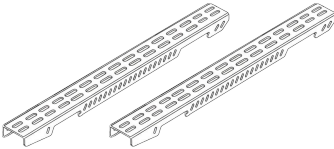
- 1) Avoid airflows from air conditioning or heating vents directed towards the LED screen.
- 2) Do not install in high-humidity locations.
- 3) Use the dedicated power cable designed for this product due to high power consumption.
- 4) Ensure floor stability and adequate voltage supply from power outlets.
- 5) Wear protective gear, such as gloves and safety shoes, at all times.

Accessories List

 Bluetooth Remote	 Control Box	 LED Module	 Toolbox
 LED Cabinet	 Movable Base (Optional)	 Wall Mount	 Magnet Adjustment Tool
			 Manual Suction Cup
			 Wrench
			 Screwdriver
 Screw	 Brackets	 Front Connector	
 Network & Power Cables	 Gloves	 USB Drive	

Movable Base Installation (optional)

This LED display is installed on a movable base



Pre-Installation Instruction

- 1) Avoid moving the screen over cables or on uneven, dirty, soft, or steep surfaces.
- 1) Stay clear of wheel sections to avoid injury.
- 1) Do not move the base by pushing the LED screen.
- 1) Do not push from the front of the LED screen or attempt to lift it.

Movable Base Installation (optional)

Connect the upper and lower beams to the side brackets using M6x12 countersunk screws.

1



Back

2



3



Wall mounted installation

The installation position of the first rail determines the overall installation position.

1 Align the first rail

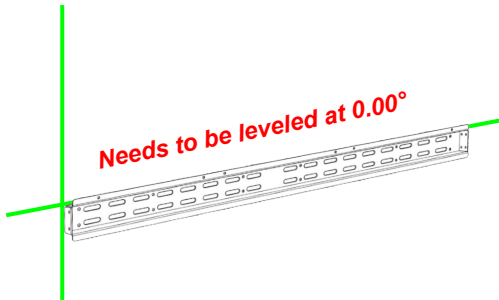

Installation Sequence

1. Loosely attach the power distribution bar to the top rail using the provided 4-inch machine screws.
2. Do not fully tighten hardware at this stage.
3. Install 4-inch mounting screws through the pre-drilled left and right mounting points of the power distribution bar into the threaded holes in the middle support rail.
4. Tighten all 4-inch machine screws on the top and middle support rails.
5. Secure the middle support rail to the wall using hardware appropriate for the wall substrate.
6. Install and secure the wall controller.

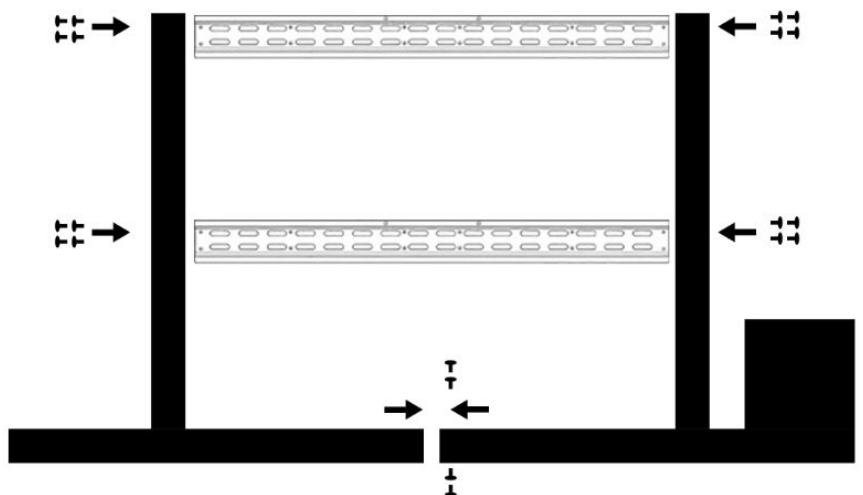
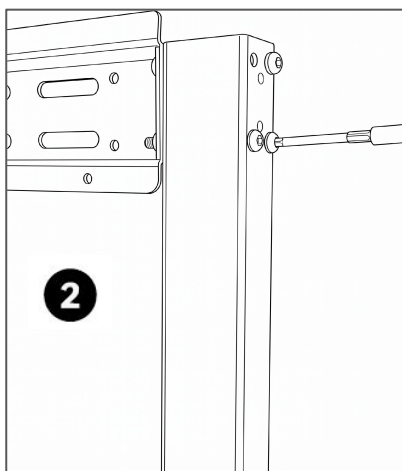

Network/Power Connections

Connect the network/power cables between the modules and then connect the interface to the control box.

PS: Red: Interface that needs manual access | Green: Routing.

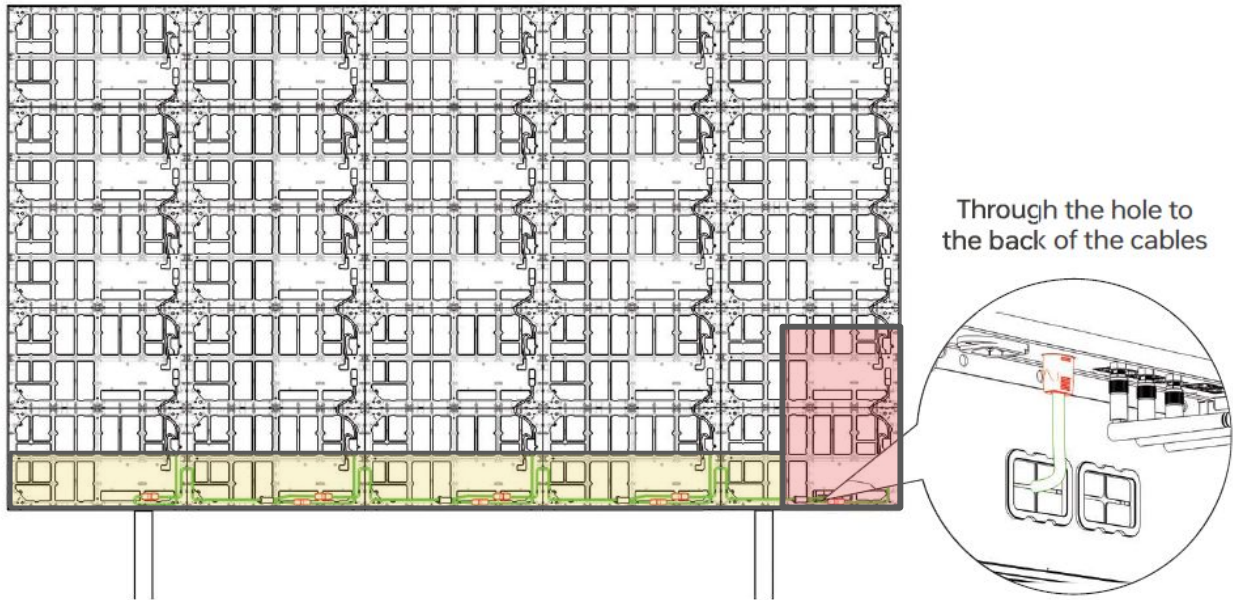

Screen Installation

- 1) Attach the clip to the back cover of the cabinet.
- 2) Install the cabinets one by one on the beams of the Wall Mount.

1 Not required by default

Column P1
forth to mount

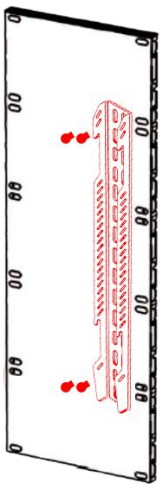

Column P2
first to mount

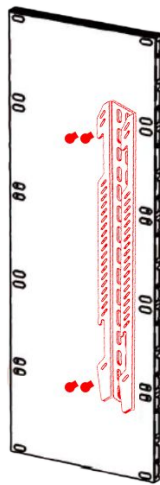

Column P3
first to mount

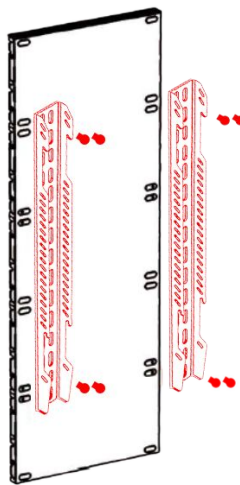

Column P4
third to mount

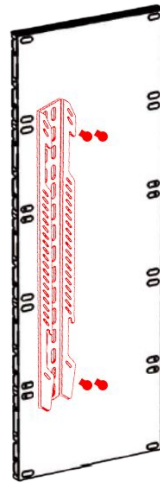

Column P5
fifth to mount

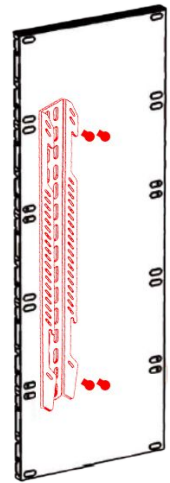

2

Column 3, must be aligned to this nub to be centered on the wall.

(Looking from above)

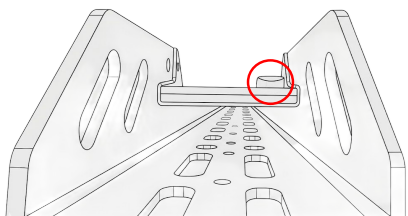

Panel

Right Side



Screen Installation

- 3) Respect the assembly order.
- 4) Verify if everything is fully engaged.

3 Assembly Order

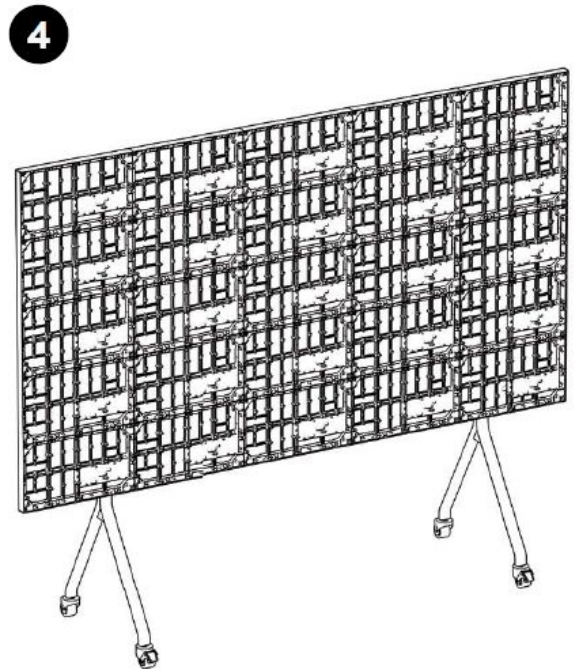
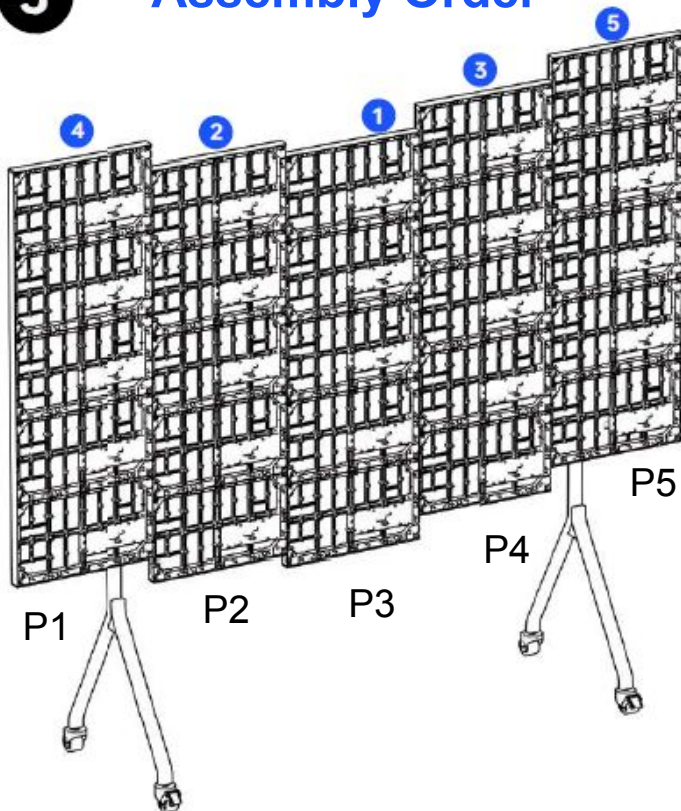

Front Connecting Block

5) Attach the front connector and M6x30 screws to the cabinets.

5

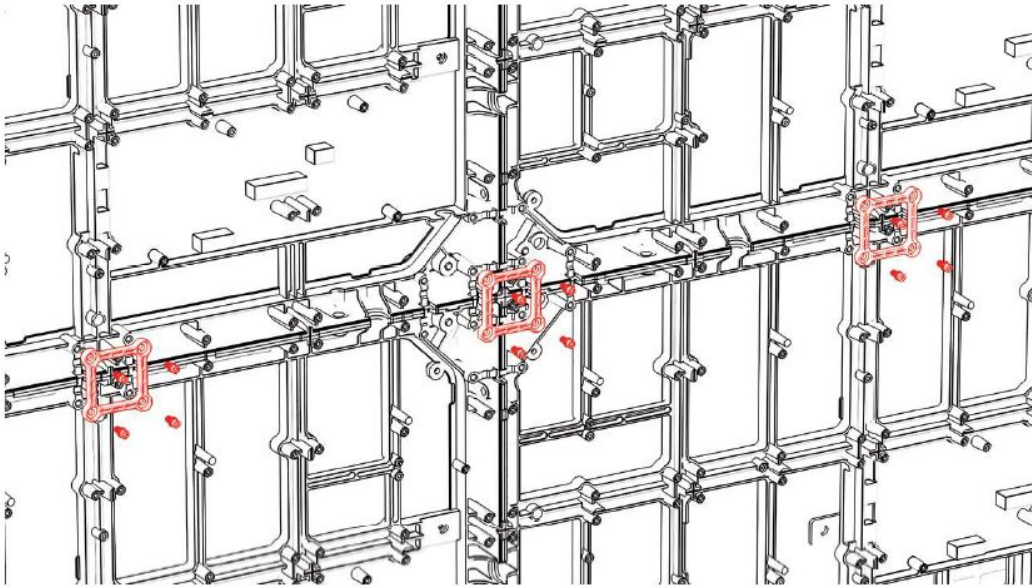

6

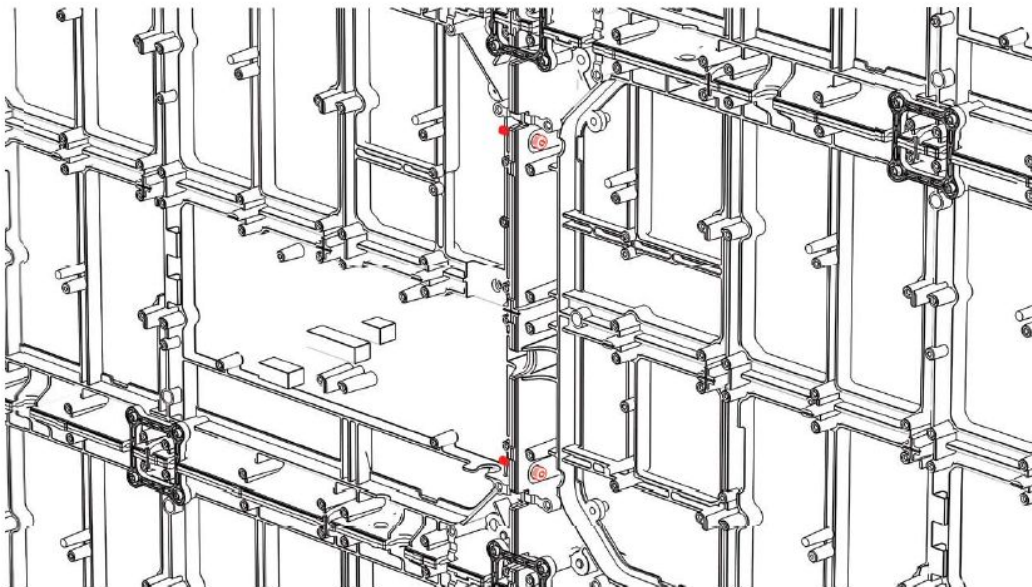

7) Engage all the camlocks using 5mm hex driver.

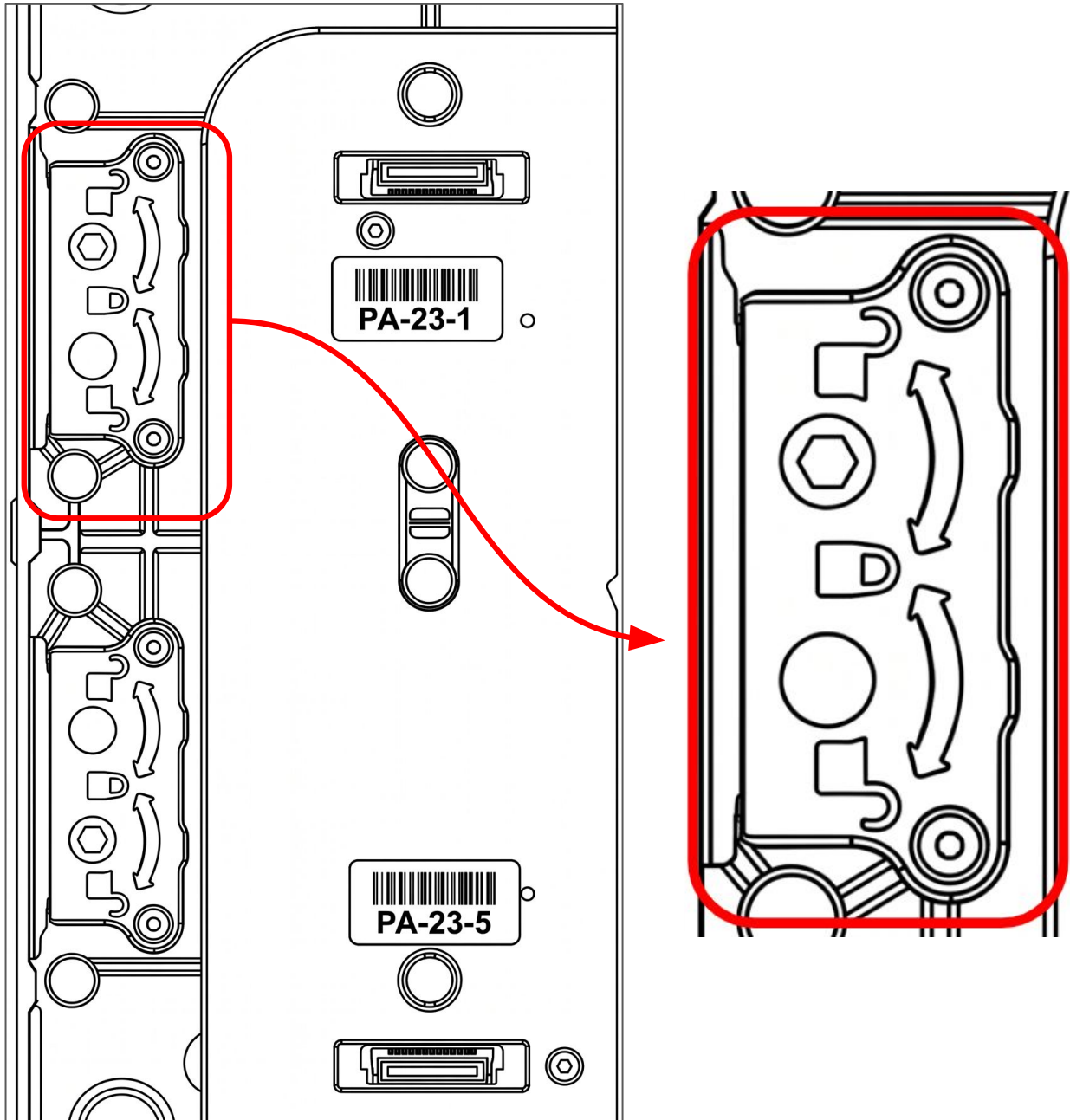

8) Apply Trim before modules.

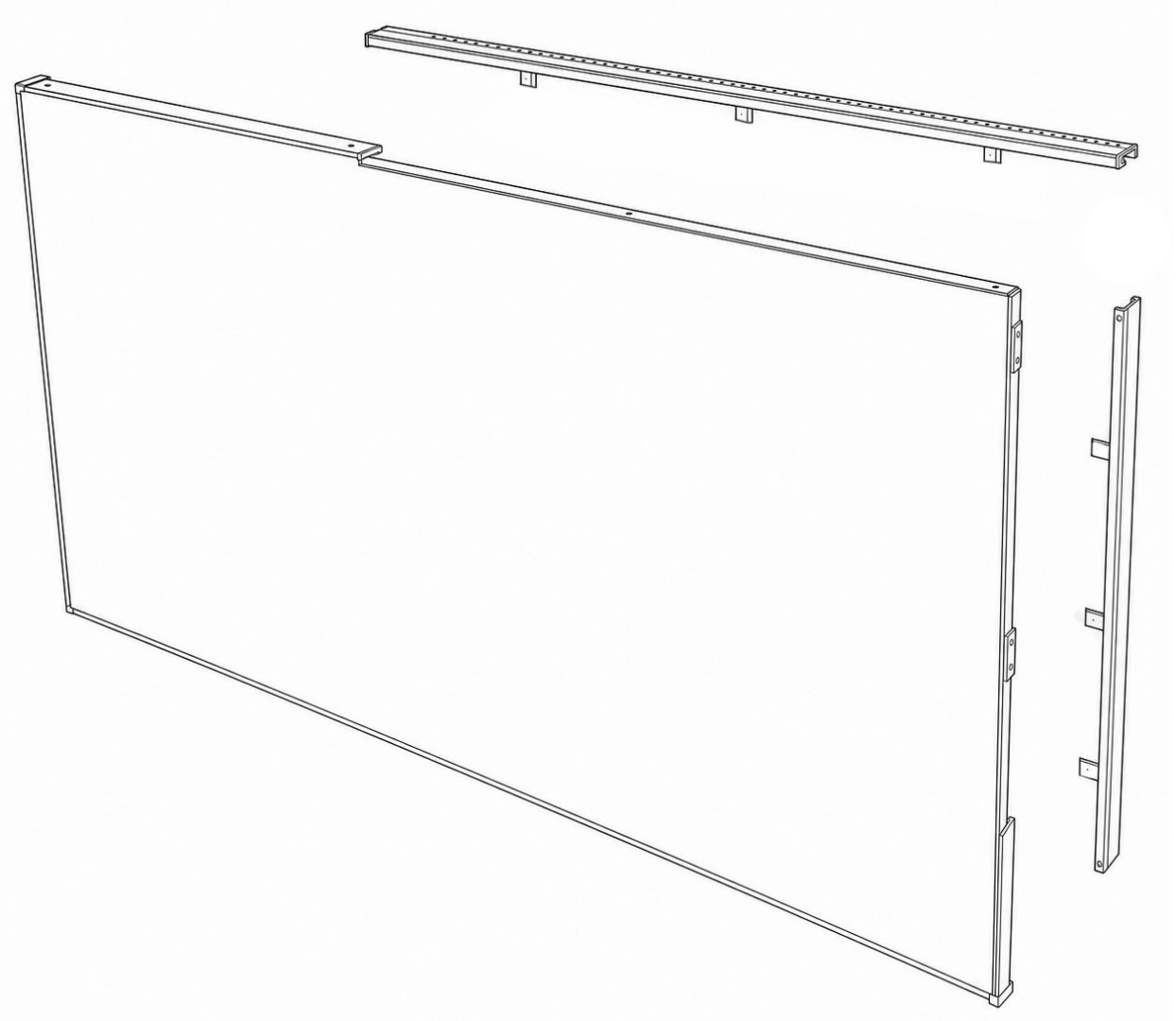

LED Module Installation



Precautions

- 1) Wear anti-static gloves before installing the LED modules.
- 2) Remove watches, rings, bracelets, or any metal objects to prevent direct contact with LED modules.
- 3) Must match the numbers correctly.

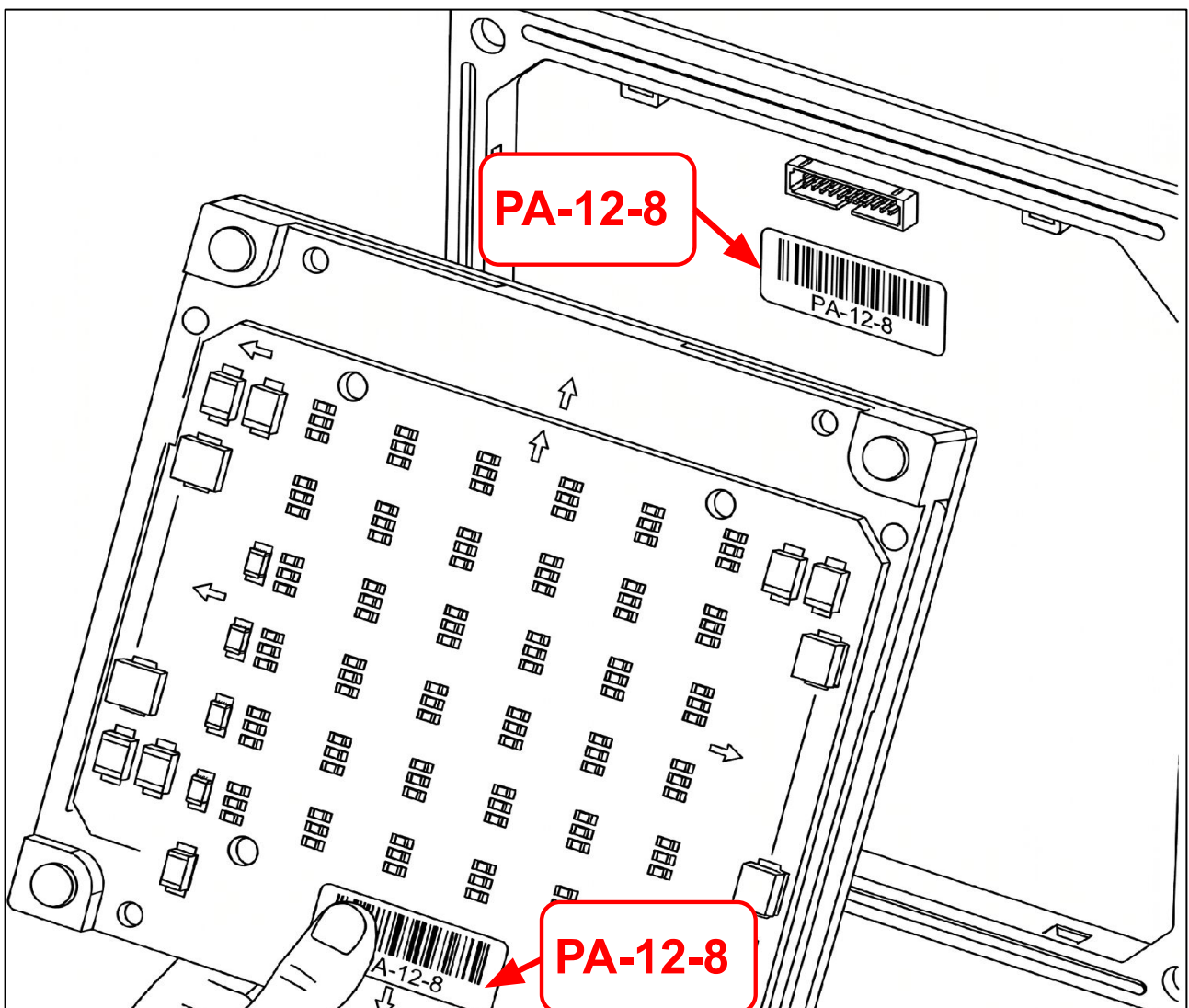

Mounting the Module Structure

- 4) The arrow mark on the back of the LED module should face upwards
- 5) Start from the middle module at bottom, aligning each LED module with the cabinet, then carefully press the module into place.

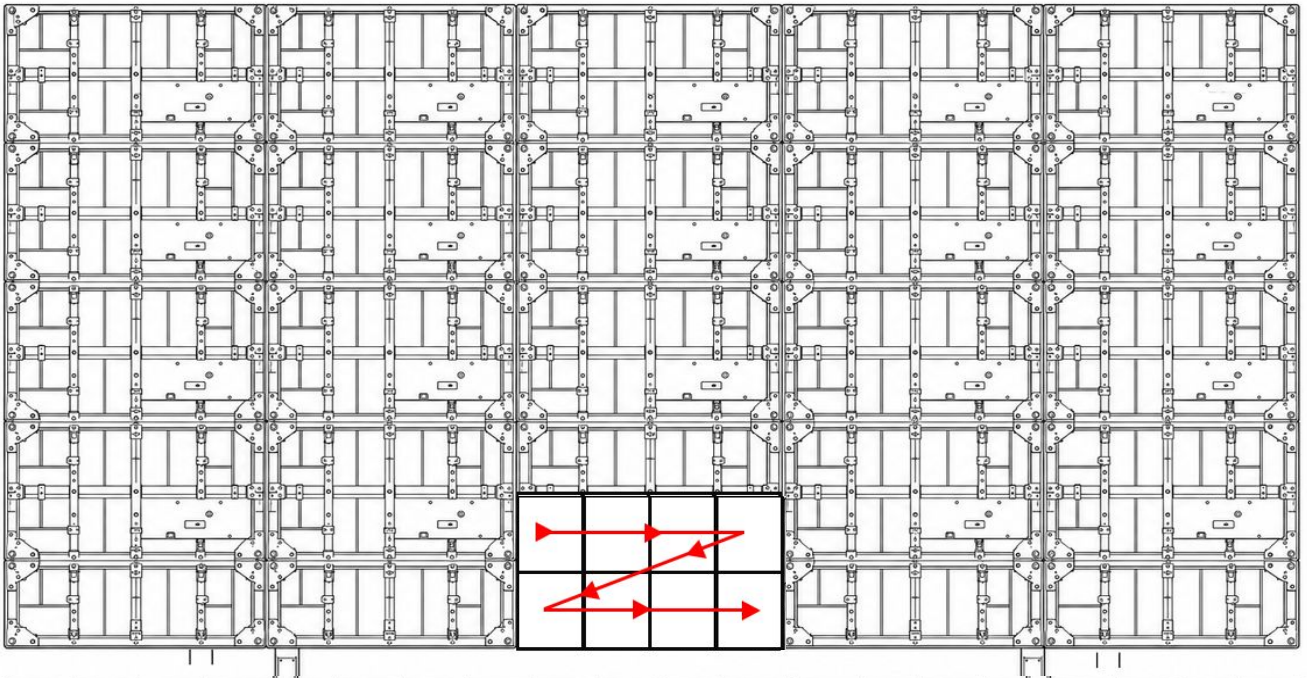

	B-1				B-2				B-3				B-4				B-5			
B-1-5	B-1-6	B-1-7	B-1-8	B-2-5	B-2-6	B-2-7	B-2-8	B-3-5	B-3-6	B-3-7	B-3-8	B-4-5	B-4-6	B-4-7	B-4-8	B-5-5	B-5-6	B-5-7	B-5-8	
A-1-1	A-1-2	A-1-3	A-1-4	A-2-1	A-2-2	A-2-3	A-2-4	A-3-1	A-3-2	A-3-3	A-3-4	A-4-1	A-4-2	A-4-3	A-4-4	A-5-1	A-5-2	A-5-3	A-5-4	
	A-1				A-2				A-3				A-4				A-5			
A-1-5	A-1-6	A-1-7	A-1-8	A-2-5	A-2-6	A-2-7	A-2-8	A-3-5	A-3-6	A-3-7	A-3-8	A-4-5	A-4-6	A-4-7	A-4-8	A-5-5	A-5-6	A-5-7	A-5-8	

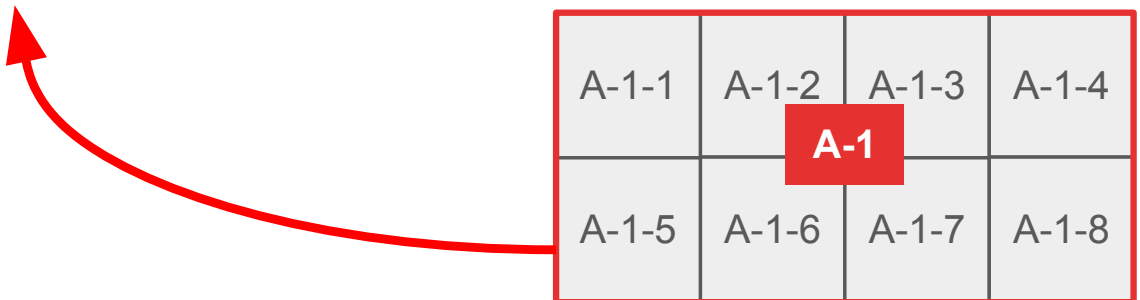

Mounting the Module Structure

- 6) Install modules from the middle outwards, ensuring the module number corresponds with the cabinet.

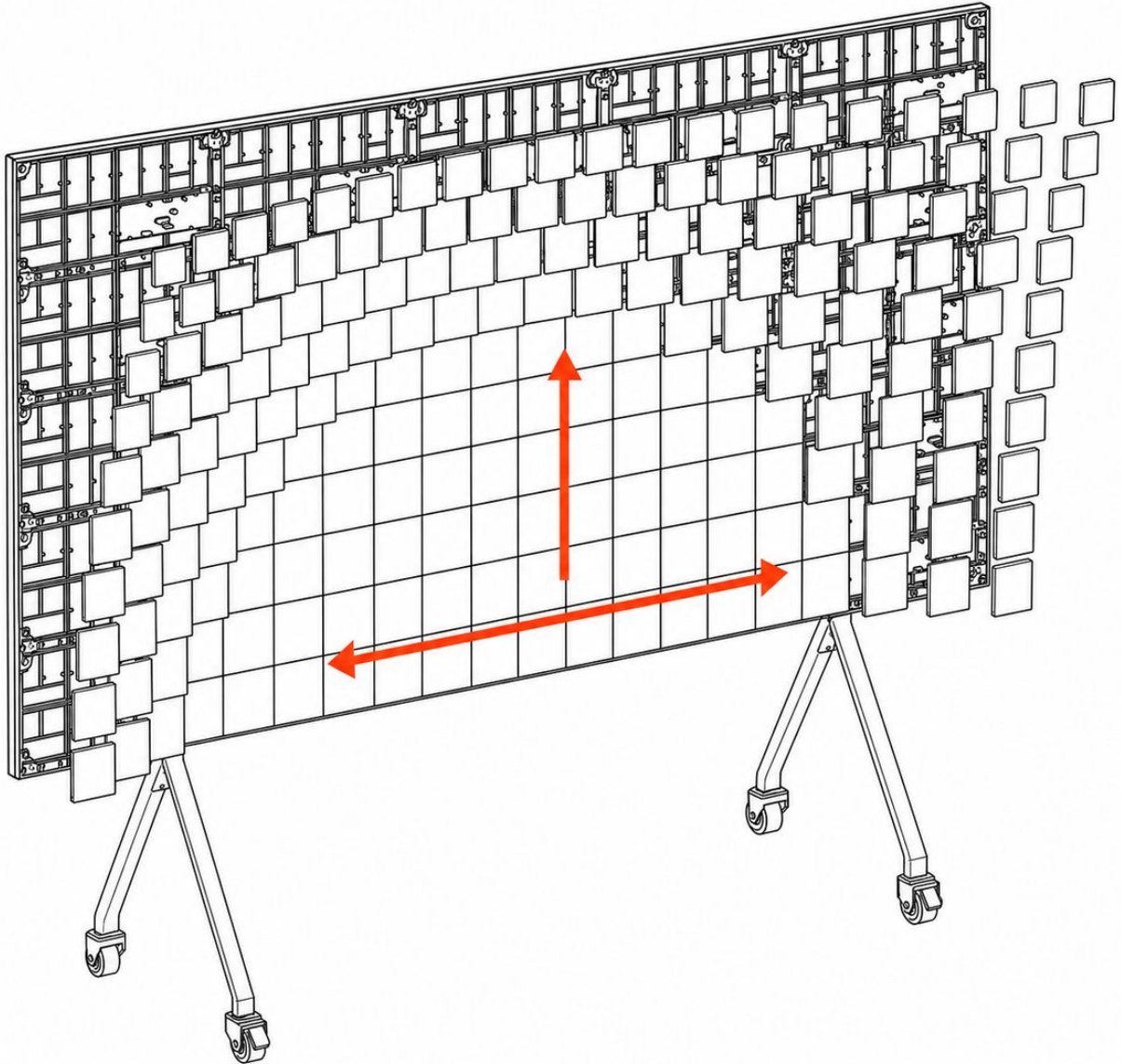

Powering On the LED Screen

Press the power button to turn on the LED screen.

1

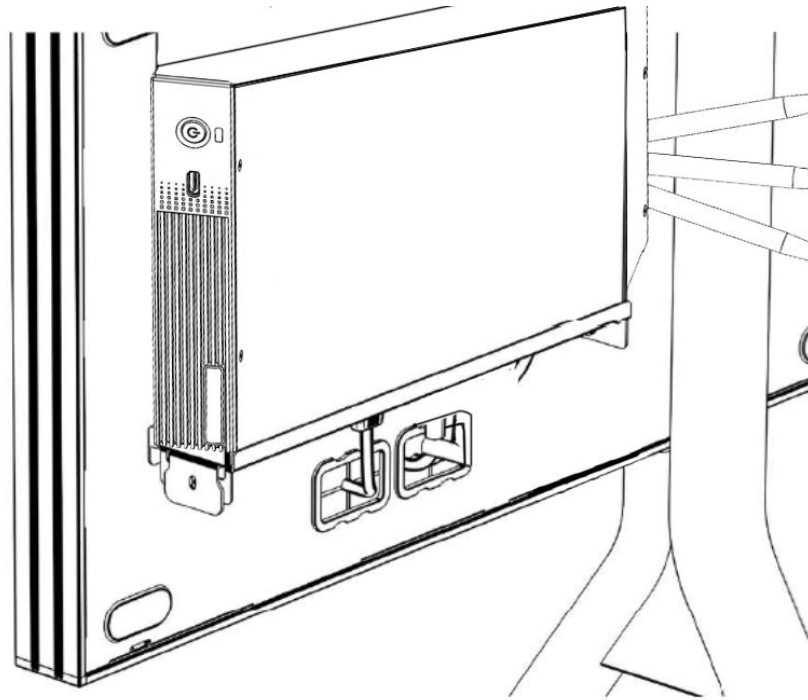

2

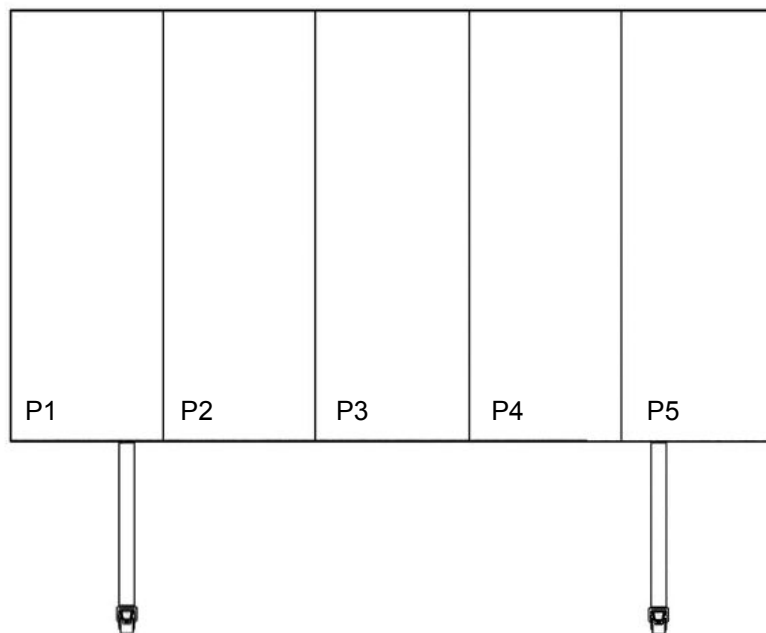

Maintenance & Service

Cleaning Recommendations

- Use a microfiber towel and non-ammonia-based cleaner
- Lightly mist cleaner onto the towel only – never spray directly onto LED modules
- Follow with a dry microfiber towel

Module Replacement

- Remove modules using the provided orange suction-cup tool
- Replace only with approved Pensar replacement components
- Verify replacement module orientation before installation

WARNING: Disconnect power before performing service procedures.

